

# Universal Replacement Autopilot (URAP) Program

**Jon Bruns**

**Boeing Phantom Works - Advanced Tactical Missiles**

**(636) 925-6437**

**jon.bruns@boeing.com**



# Moving End Point Capability

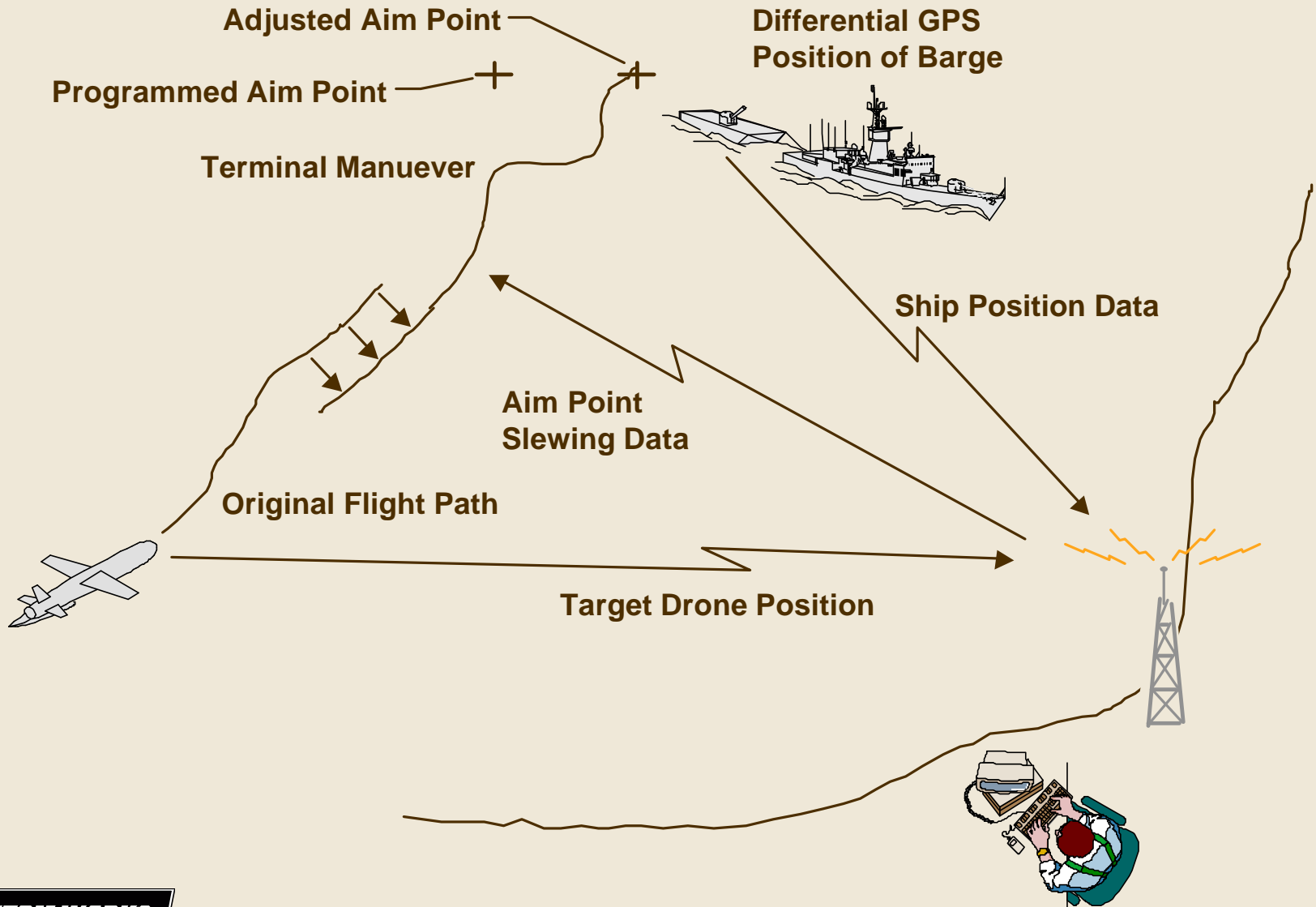

# Low Altitude Sea Skim Capability

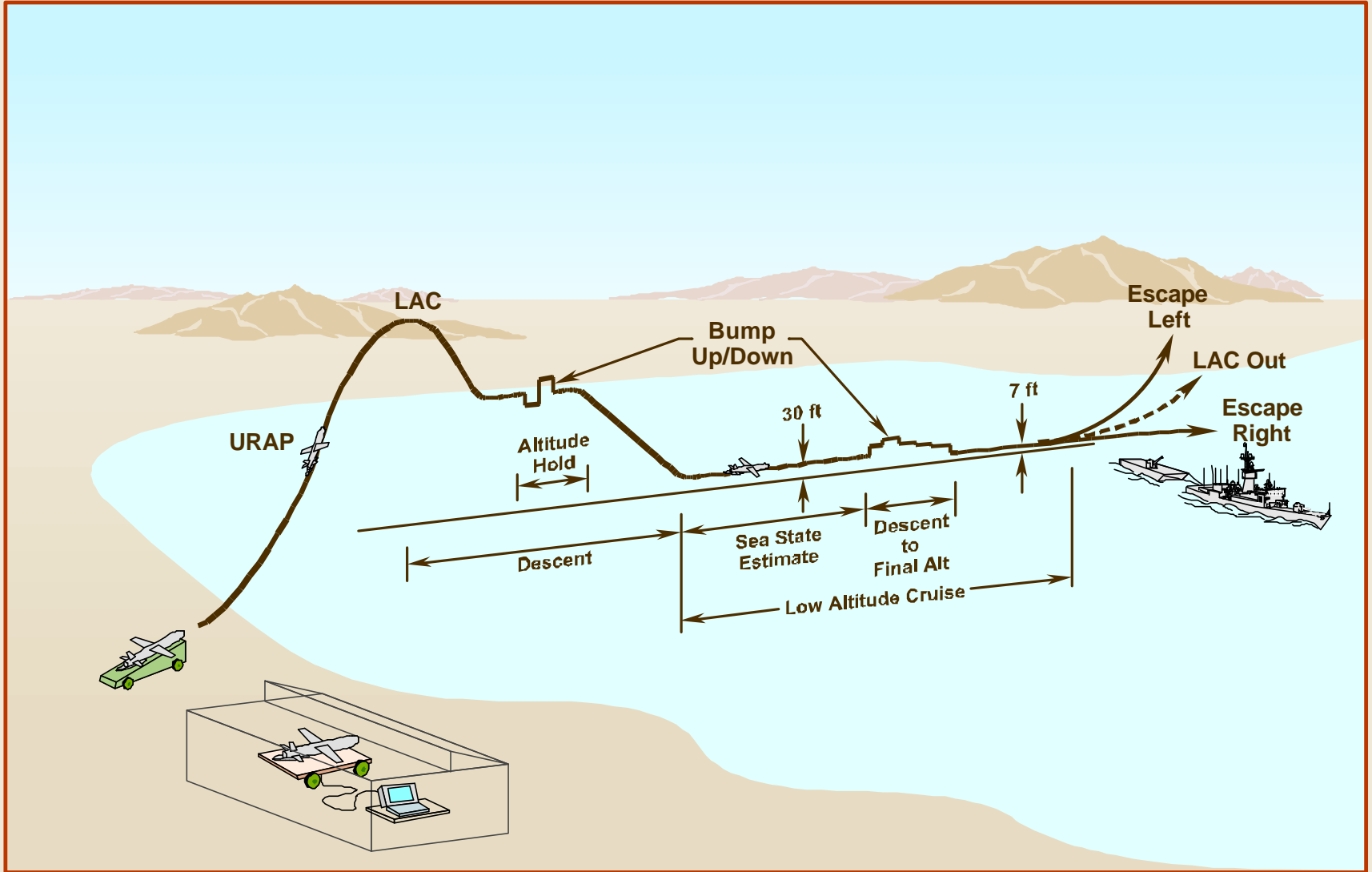

# Concept of Operations

## In-Flight Operator Commands

### In Programmed Flight:

- Instant Recovery
- Delayed Recovery
- Payloads
- Mission Selection (8)
- Manual Takeover
- Moving End Point
- Altitude Updates

### In Manual Flight:

- Radio Pitch & Roll Control
- Heading Hold
- Altitude Hold
- Return to Automatic
- Mission Selection (8)
- Preplanned Maneuvers
- Engine Control
- Altitude Updates

## Preplanned Maneuvers

- Low Altitude Cruise/Sea Skimming
- Weave
- Pop-Up
- Escape Left/Right
- Delayed Recovery
- Instant Recovery

## Mission Load

- Low Altitude Cruise Altitude
- Waypoints (X,Y)
- Recovery Point
- Altitude Profile
- Engine RPM
- Turn Radius
- Preprogrammed Maneuvers
- Payload Commands
- Programmable Radio Link Loss Delay

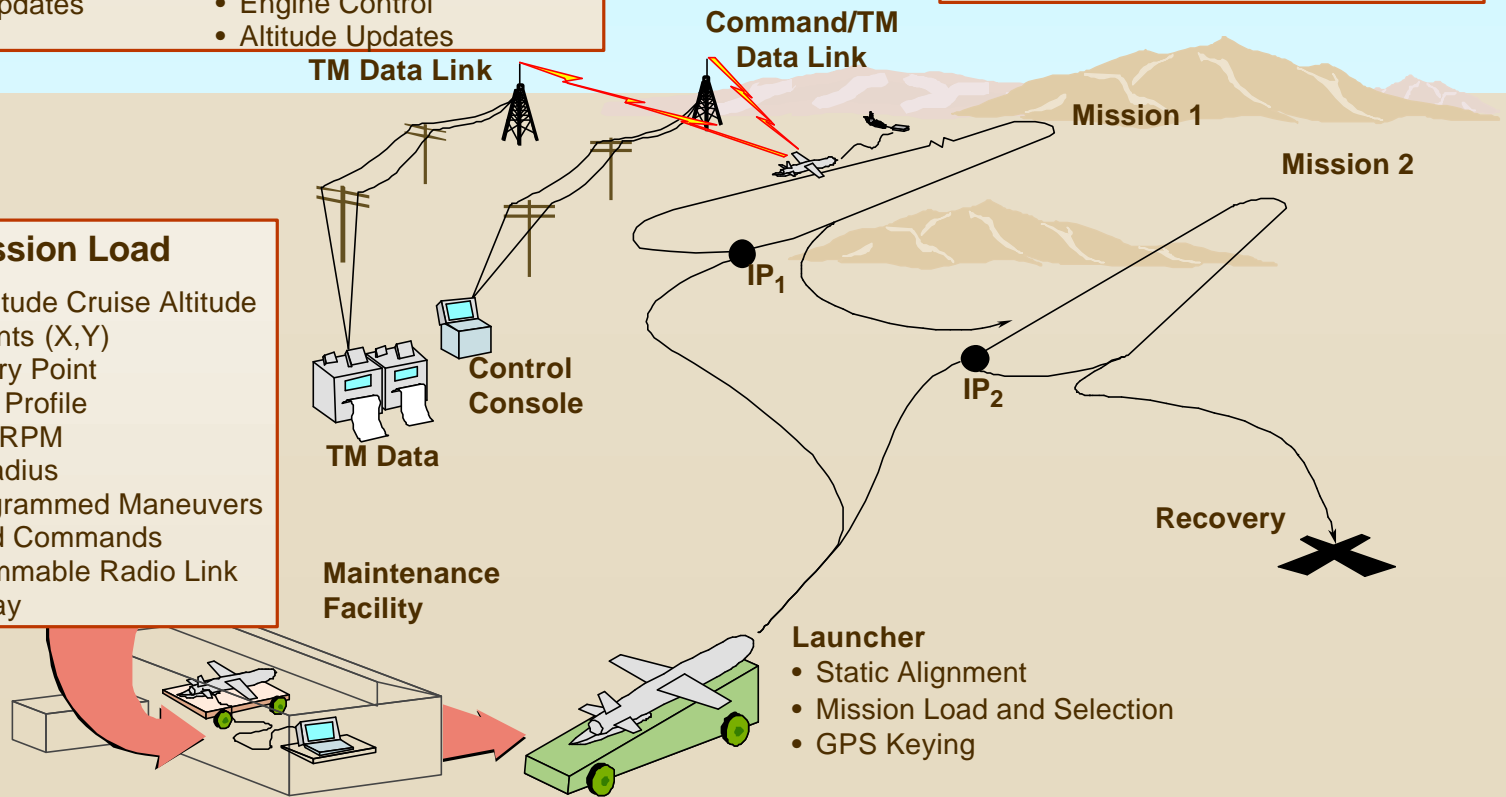

# Demonstrated Low Altitude Weave Maneuver

URAP Flight 10 Weave 4

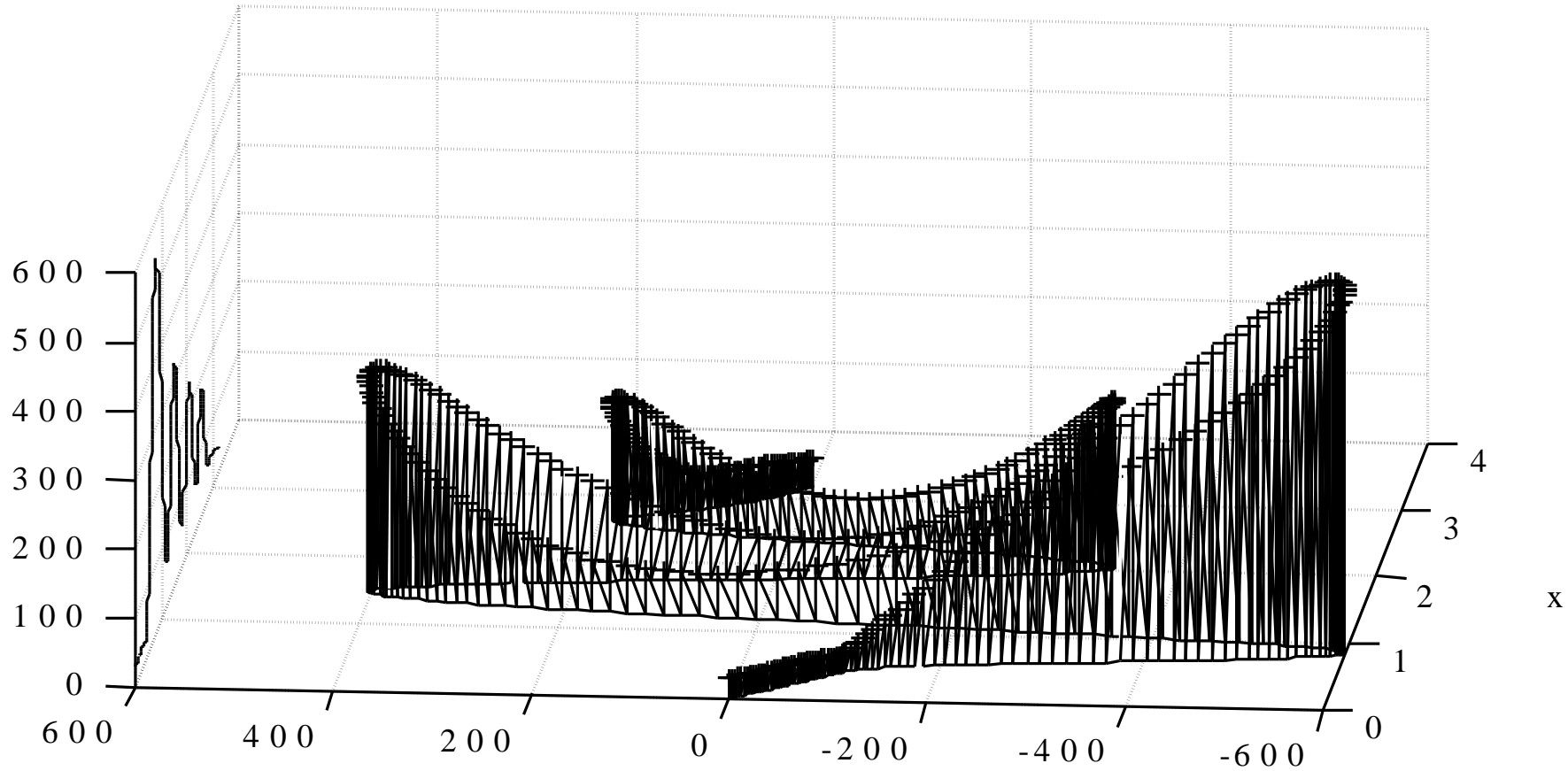

# URAP Guidance Set



- Repackaged JDAM GPS/INS Mission Computer Guidance Set With Added Board for Analog, Digital and additional Serial I/O
- Compatible With ITCS and VEGA Control Systems
- Provides Autonomous or Manual Flight Control
- Mission Planning Allows Special Maneuvers and Flight Profiles
- Low Cost
- BQM-74 Enhancements Flight Demonstrated

*Leveraging off JDAM to provide a low cost solution for improved target performance and threat simulation.*

# JDAM Provides a Low Cost, Proven, Sustainable Basis for URAP

- High volume/low cost production base (87000 Units)
- Common Software Maintenance and Upgrades
- Common Hardware Design Support and Upgrades
- Flight Proven Reliability

**JDAM GCU**

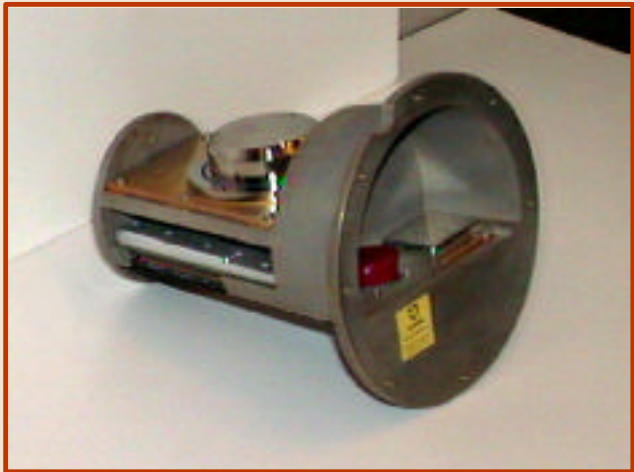

**URAP GCU and IO**

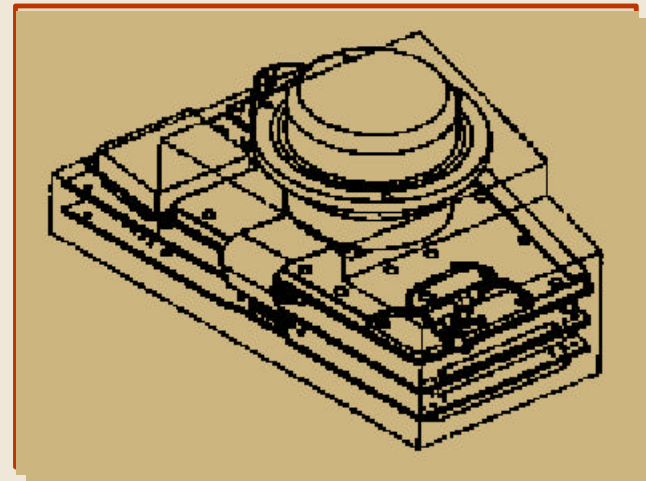

# Software Structured For Reuse

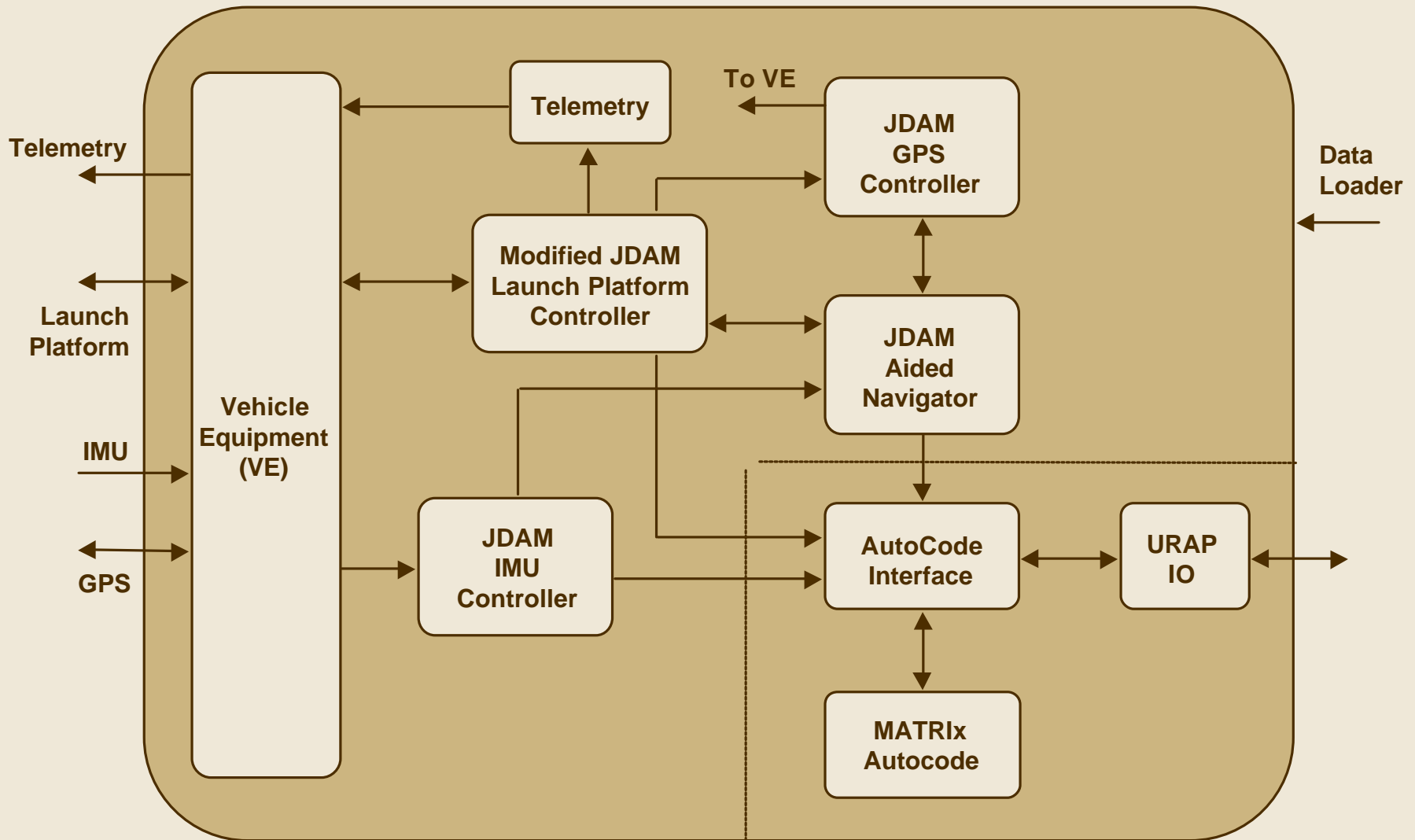



# Matrix-X Provides Flight Simulation

## Flight Simulator



## Logic Analyzer

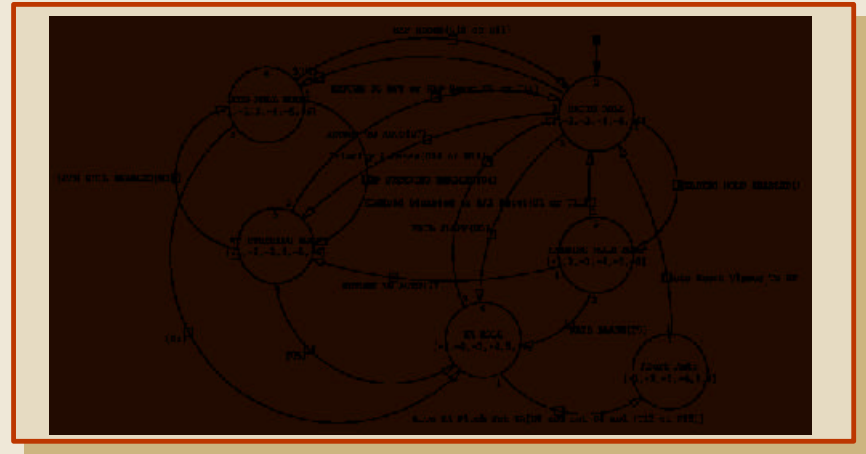

## Control Loop Generation

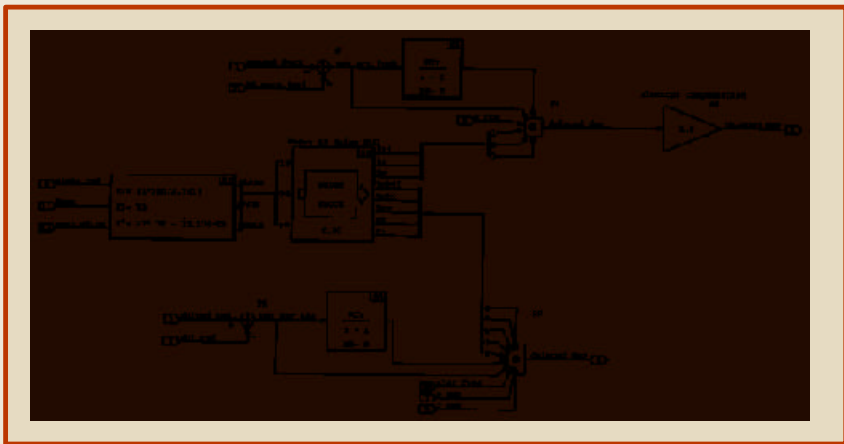

## Software Auto-Coding

```
and if,
----- Sum of Vectors -----
-- [rate limit .17] --
ROLL_CMD LIM_DMG := CMD P + DELTA S1_DMG;
----- Gain Block -----
-- [rate limit 0.75] --
DTX_1 := 0.017453292519943295*ROLL_CMD LIM_DMG;
----- Sum of Vectors -----
-- [Weave Autopilots .56] --
phi_err_rad := DTX_1 - W.phi_rad;
----- 1st Order Integrator -----
-- [Weave Autopilots .53] --
if INIT and ANEWAP then
  I.Weave_Autopilots_53_S1 := I.Weave_Autopilots_53_S1 - W1_SIGN*(T*WAP)
  phi_err_rad;
and if;
Weave_Autopilots_53_1 := I.Weave_Autopilots_53_S1 - W1_SIGN*(T*WAP) +
  phi_err_rad;
----- Sum of Vectors -----
-- [Weave Autopilots .49] --
acc_err_ips2 := Y.coupled_ips2 + U.AE_weav_ips2;
----- 2nd Order Integrator -----
-- [Weave Autopilots .55] --
if INIT and ANEWAP then
```

# MATRIX-x Enables Efficient Re-host and Modification of Guidance Laws

- **Validate Existing Control Loops and Vehicle Logic**
- **Develop New Control Loops and Vehicle Logic**
- **Complete Simulation of System - Ground Control Segment and Vehicle Segment**
- **Software Generation (Autocode)**
- **Software Validation**
- **Software Documentation**
- **Software Module Reuse**

***MATRIX-x Is a Significant Labor Saving Tool That Allows Rapid Development/Changes to Flight Software***



# URAP Program Status

- **24 Kits Built for BQM-74 Target Drone**
- **17 BQM-74 Flights Performed Successfully Demonstrating:**
  - INS/GPS Navigation
  - Manual & Autonomous Flight Control
  - Manual to Autonomous & Autonomous to Manual Handover
  - In-Flight Mission Selection
  - Altitude and Heading Hold
  - Low Altitude Sea Skimming
  - Weave Maneuver with Moving End Point
  - Recovery (Manual and Autonomous)
  - Left & Right Escape Maneuvers
  - In Flight Updates of Programmed Altitudes (Bump Up/Down)
- **Delivery of 37 more units in CY 2000**



# Summary - URAP Benefits

- **Reduced Cost for GPS/INS Capability**
- **Flexibility to Modify Flight Profiles to User Requirements**
- **Compatible with Existing Ground Stations**
- **Autonomous and Manual Flight Control**
- **Uniform and Repeatable Flight Profiles with Accurate Time, Space and Attitude Data**
- **Single Set of Tools/ Processes/Simulations for Multiple Vehicles**